

# Abgeordnete

parlamentsmedlem

Substantiv – der (m)

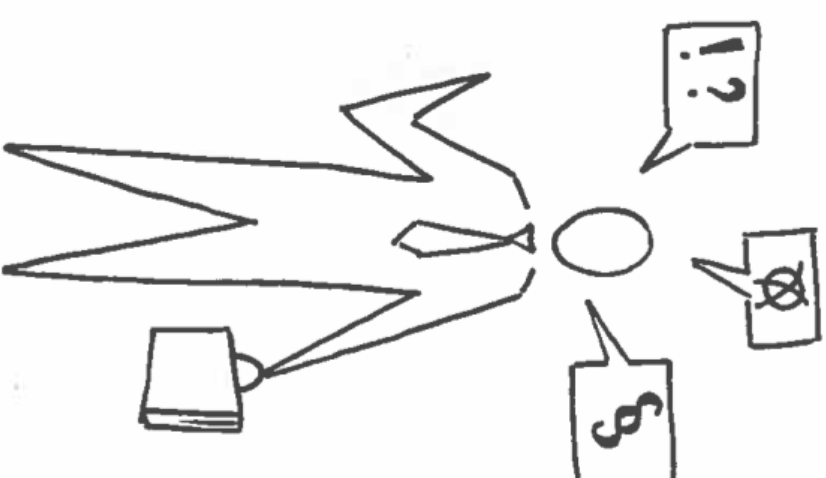

DE:

\_\_\_\_\_

DK: parlamentsmedlem

Wortklasse:

\_\_\_\_\_

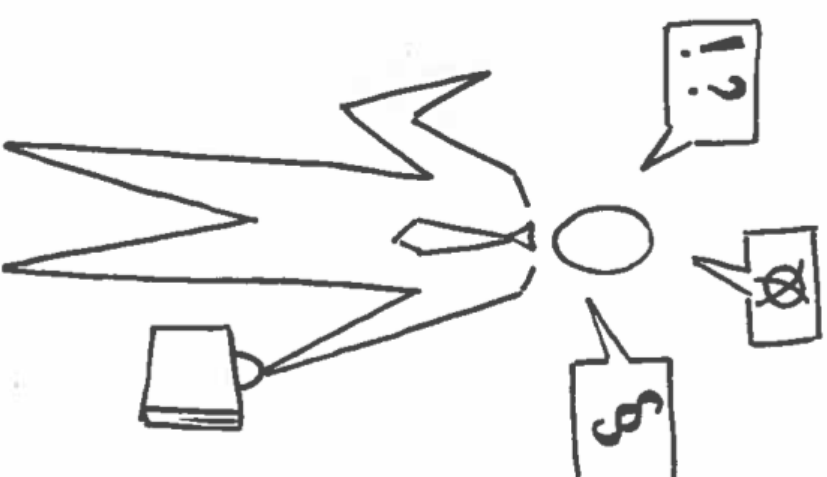

# Bürger

borger

Substantiv – der (m)

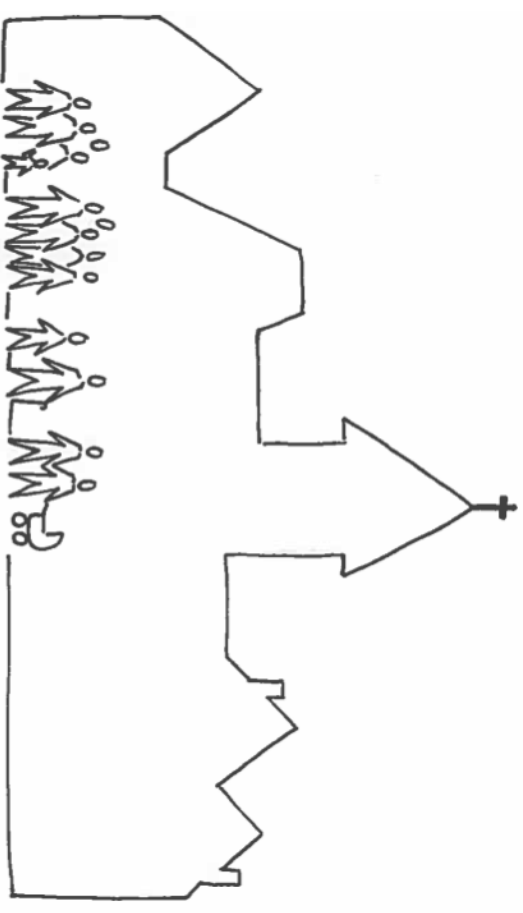

# WANDWÖRTERBUCH!

DE:

---

DK: borger

Wortklasse:

---

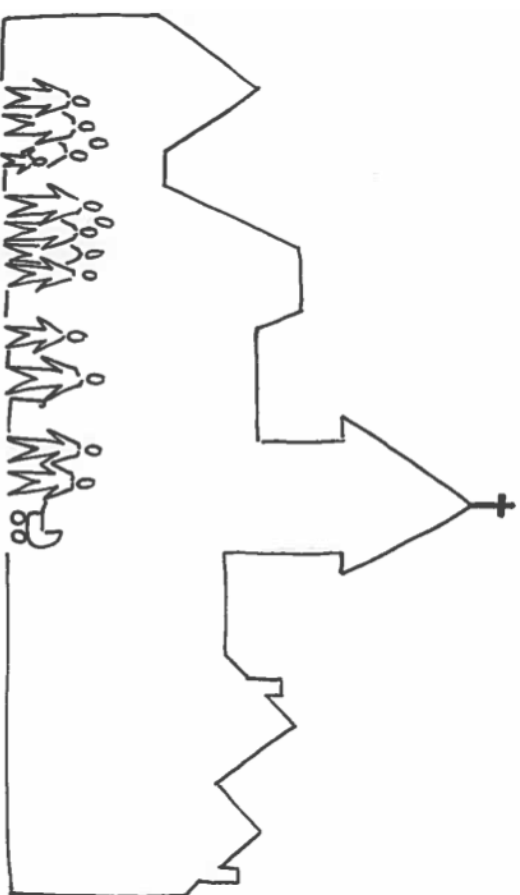

entscheiden

beslutte

Verb

JA

NEIN

VIELLEICHT

# WANDWÖRTERBUCH!

DE:

\_\_\_\_\_

DK: beslutte

Wortklasse:

\_\_\_\_\_

JA

NEIN

VIELLEICHT

# Entscheidung

beslutning

Substantiv – die (f)

JA

NEIN

VIELLEICHT

# WANDWÖRTERBUCH!

DE:

\_\_\_\_\_

DK: beslutning

Wortklasse:

\_\_\_\_\_

JA

NEIN

VIELLEICHT



geheim

hemmeligt

Adjektiv

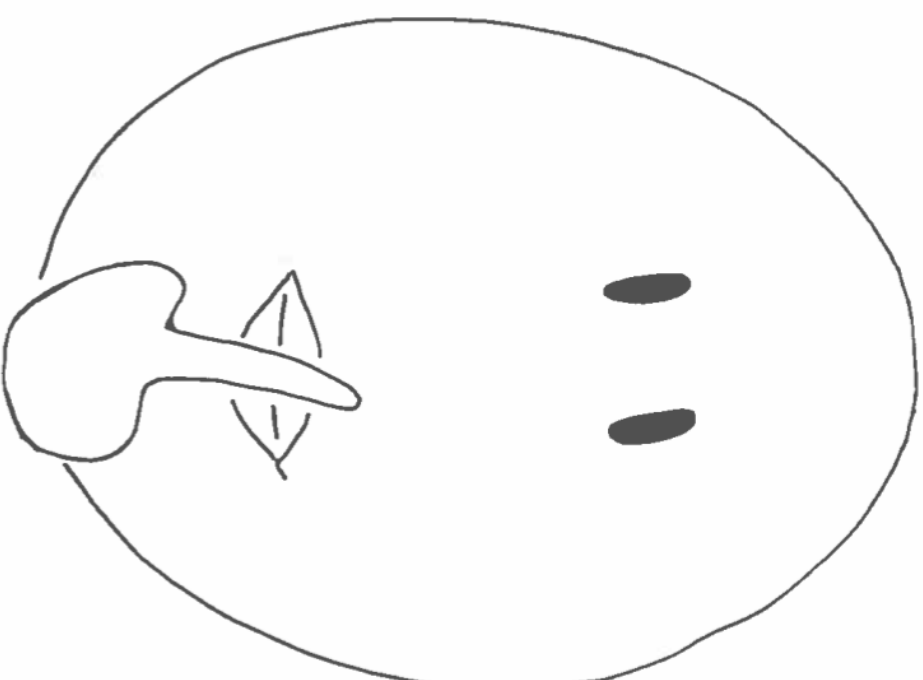

DE:

\_\_\_\_\_

DK: hemmeligt

Wortklasse:

\_\_\_\_\_

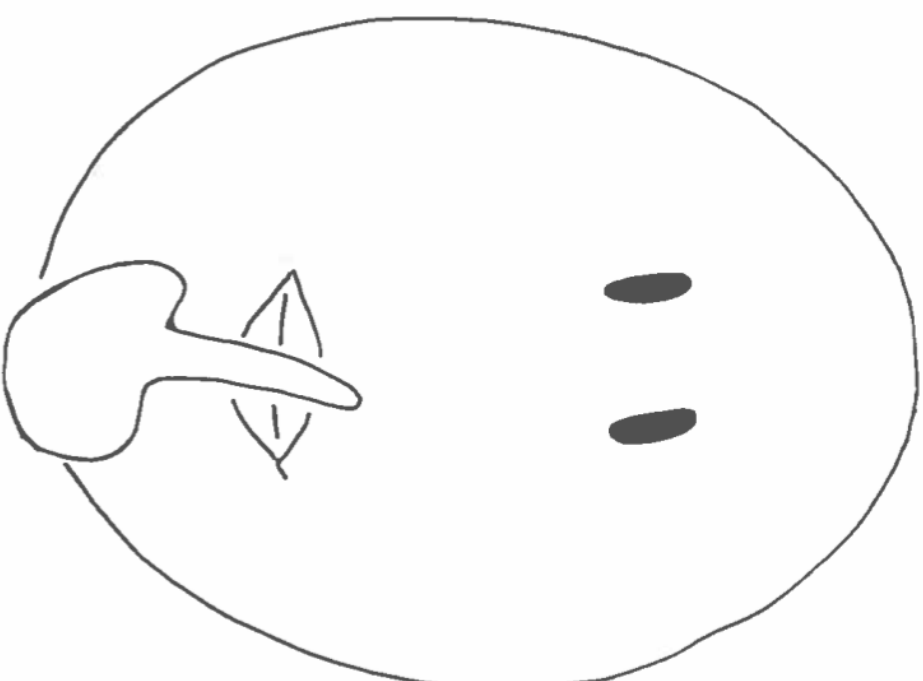

# Gesetz

lov

Substantiv - das (n)

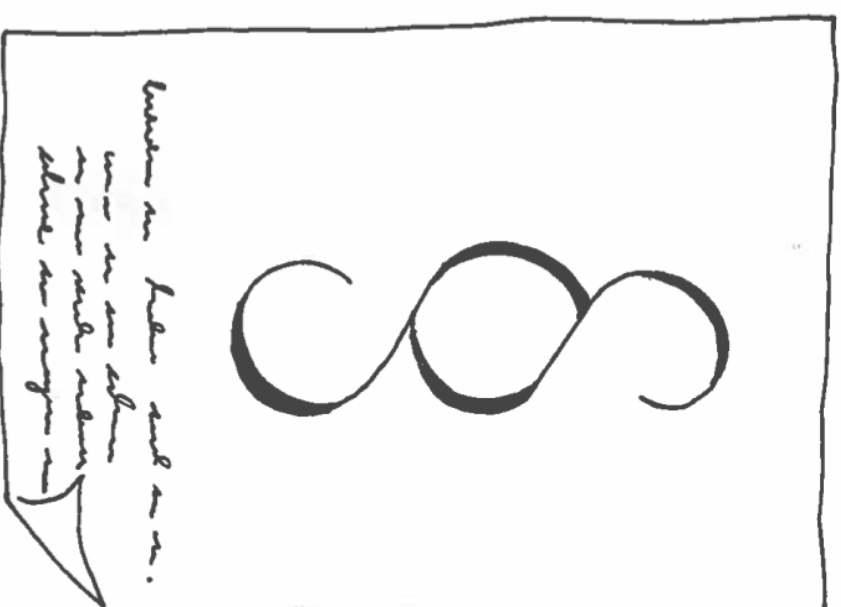

# WANDWÖRTERBUCH!

DE:

\_\_\_\_\_

DK: lov

Wortklasse:

\_\_\_\_\_

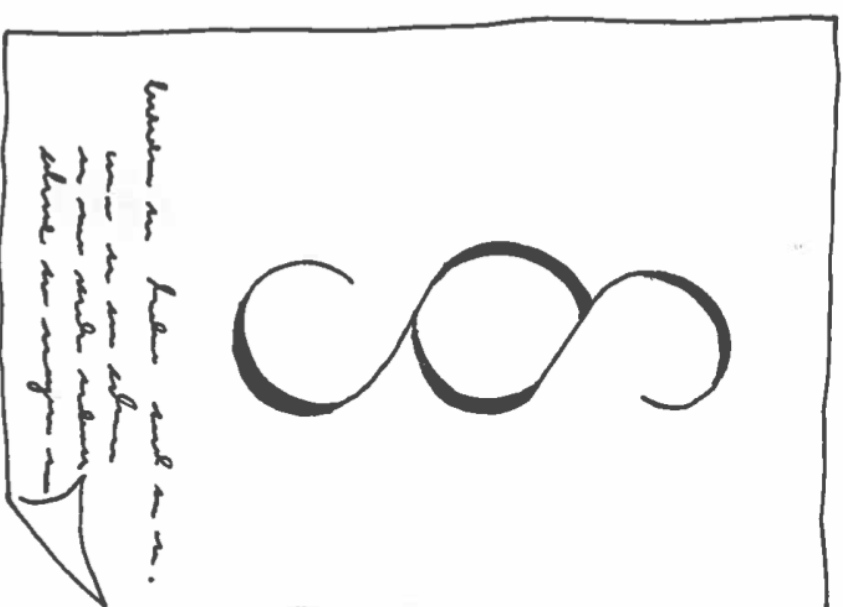

# Meinung

mening

Substantiv – die (f)



# WANDWÖRTERBUCH!

DE:

\_\_\_\_\_

DK: mening

Wortklasse:

\_\_\_\_\_



# Stimmzettel

stemmeseddel

Substantiv – der (m)

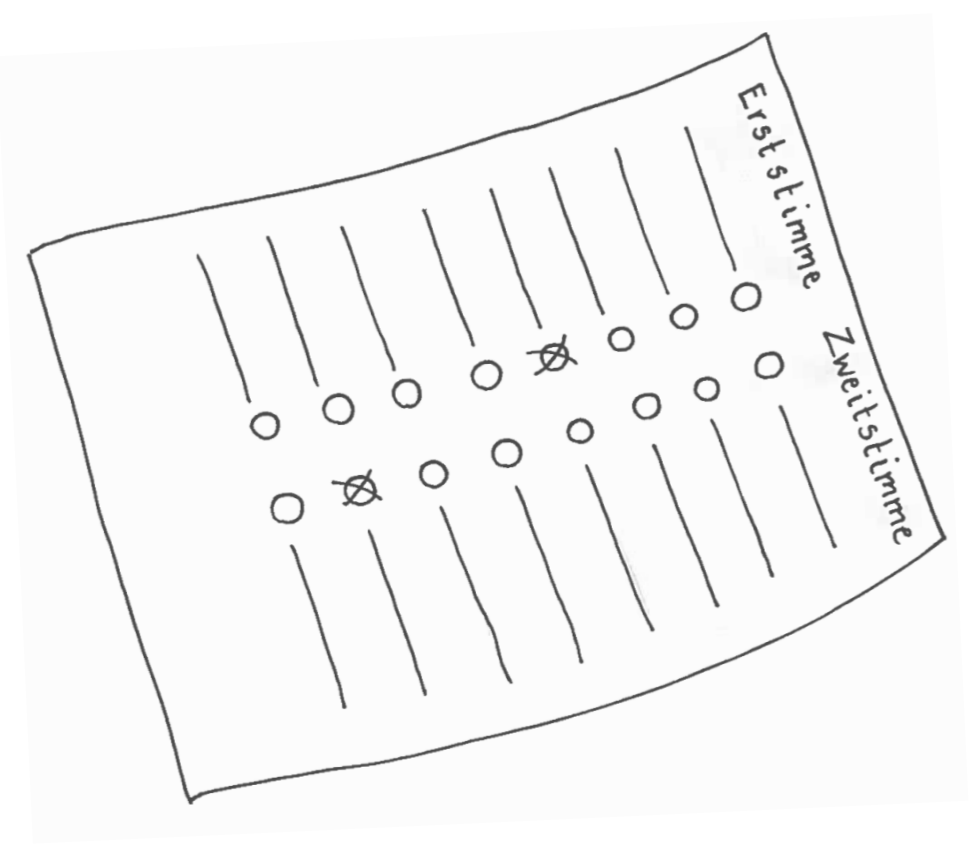

DE:

\_\_\_\_\_

DK: stemmeseddel

Wortklasse:

\_\_\_\_\_

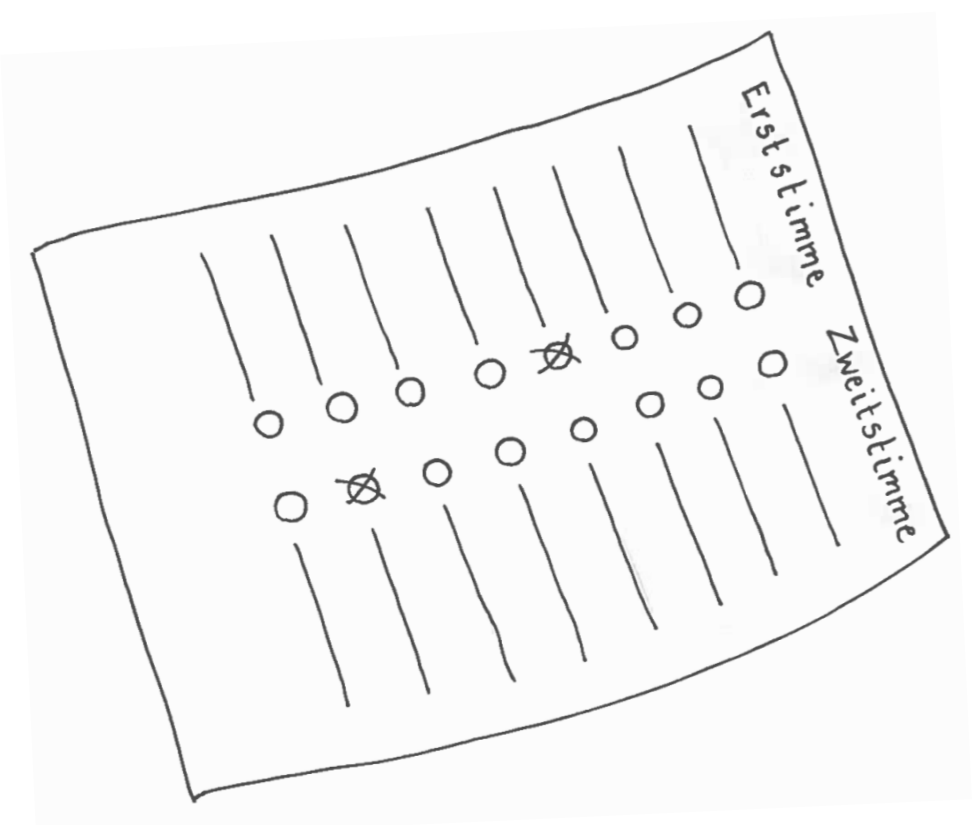



# Streit

skænderi

Substantiv – der (m)



DE:

---

DK: skænderi

Wortklasse:

---



streiten

skændes

Verb

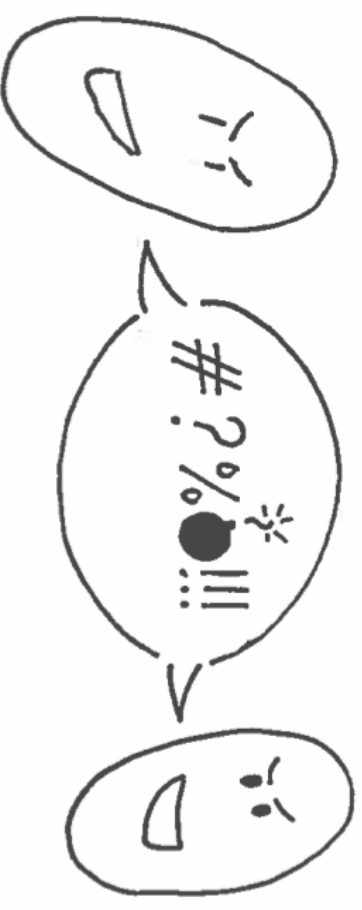

DE:

---

DK: skændes

Wortklasse:

---



überzeugen

overbevisse

Verb

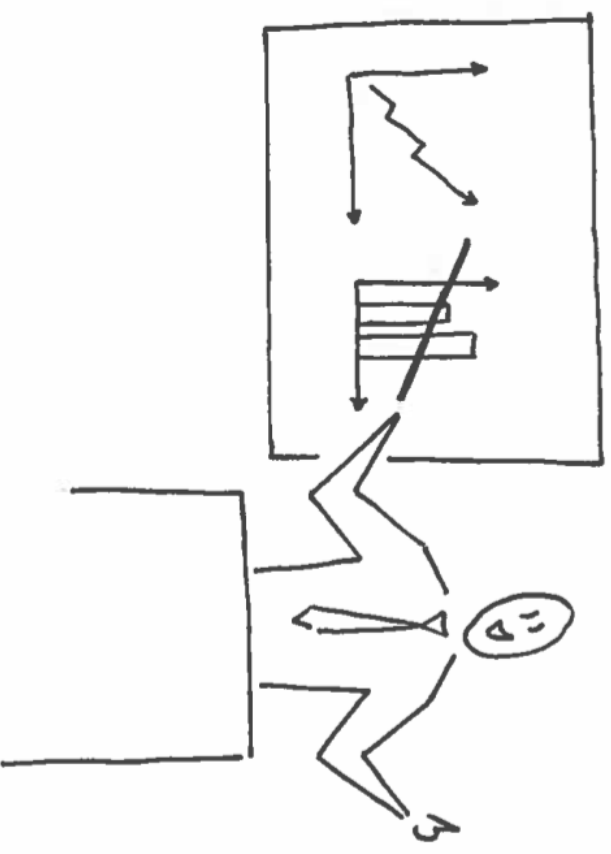

DE:

---

DK: overbevise

Wortklasse:

---

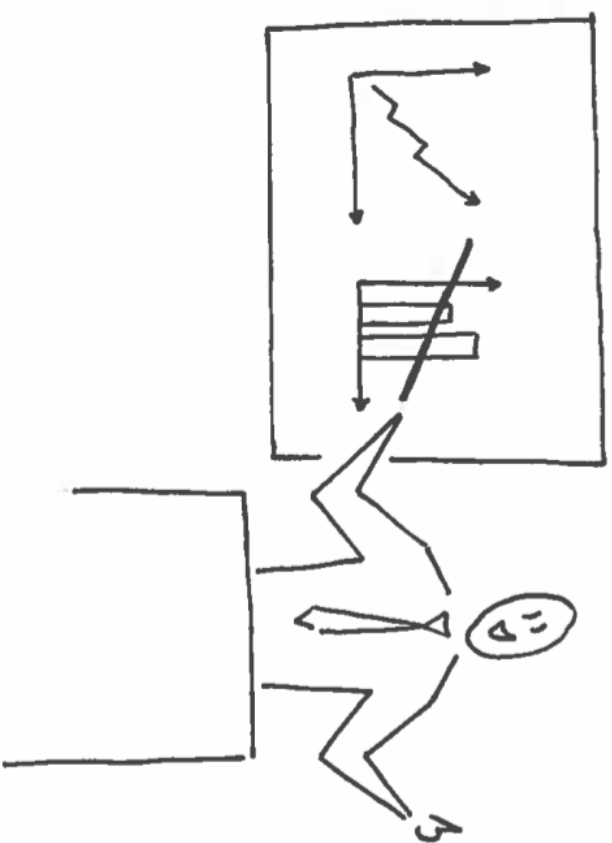

# Versprechen

Iøfte

Substantiv – das (n)

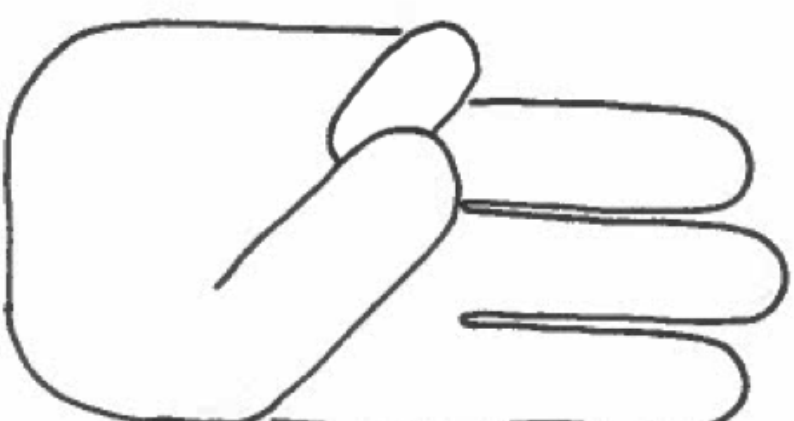

DE:

---

DK: løfte

Wortklasse:

---





Ziel

mål

Substantiv (das – n)

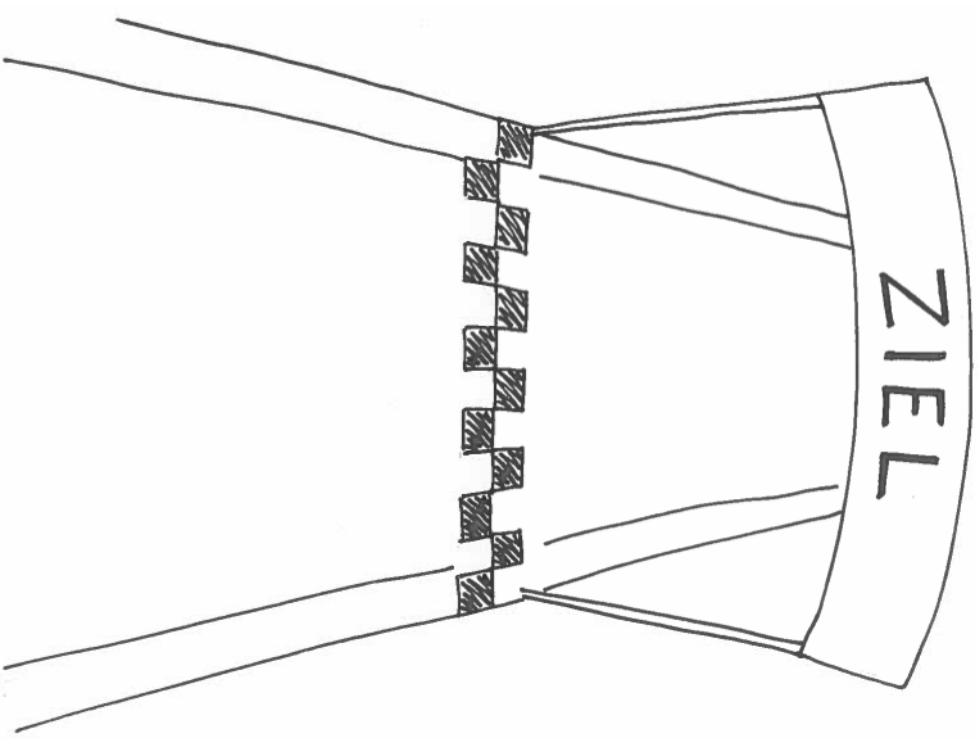

# WANDWÖRTERBUCH!

DE:

---

DK: mål

Wortklasse:

---

